



Vehicle History Report™

US \$39.99

2008 TOYOTA SIENNA CE/LE

VIN: 5TDZK23C78S210350
VAN
3.5L V6 F DOHC 24V
GASOLINE
FRONT WHEEL DRIVE



Branded Titles: Reconstructed, Salvage



Damage reported



2 Previous owners



At least 1 open recall



9 Service history records



158,074 Last reported odometer reading



This CARFAX Vehicle History Report is based only on information supplied to CARFAX and available as of 7/29/20 at 10:34:30 AM (CDT). Other information about this vehicle, including problems, may not have been reported to CARFAX. Use this report as one important tool, along with a vehicle inspection and test drive, to make a better decision about your next used car.



Ownership History

The number of owners is estimated

Owner 1

Owner 2

	Owner 1	Owner 2
Year purchased	2008	2013
Type of owner	Personal	Personal
Estimated length of ownership	4 yrs. 4 mo.	5 yrs. 9 mo.
Owned in the following states/provinces	Virginia, New Jersey	New Jersey
Estimated miles driven per year	21,720/yr	11,641/yr
Last reported odometer reading	93,790	158,074



Title History

CARFAX guarantees the information in this section

Owner 1

Owner 2

	Owner 1	Owner 2
Salvage Junk Rebuilt Fire Flood Hail Lemon	No Problem	Alert! Problem Found
Not Actual Mileage Exceeds Mechanical Limits	No Problem	No Problem















AI EDTI



Severe problems were reported by a state Department of Motor Vehicles (DMV). This

















ALERT: - Severe problems were reported by a state Department of Motor Vehicles (DMV). This vehicle does not qualify for the CARFAX Buyback Guarantee.

 Additional History Not all accidents / issues are reported to CARFAX	 Owner 1	 Owner 2
Total Loss Total loss reported on 12/27/2018.	 No Issues Reported	Total Loss Reported
Structural Damage CARFAX recommends that you have this vehicle inspected by a collision repair specialist.	 No Issues Reported	 No Issues Reported
Airbag Deployment No airbag deployment reported to CARFAX.	 No Issues Reported	 No Issues Reported
Odometer Check No indication of an odometer rollback.	 No Issues Indicated	 No Issues Indicated
Accident / Damage DMV title problems reported. Accidents reported on: 08/27/2018 and 01/07/2019. Damage reported on 10/29/2018.	 No Issues Reported	Severe Damage
Manufacturer Recall At least 1 manufacturer recall requires service. Locate an authorized Toyota dealer near you to schedule an appointment. View Toyota disclosure	 No Recalls Reported	Recall Reported
Basic Warranty Original manufacturer warranty likely voided by manufacturer after vehicle was severely damaged.	 Warranty Active	Warranty Voided

Detailed History

Owner 1 Purchased: 2008		Personal Vehicle 21,720 mi/yr
Mileage	Source	Comments
05/19/2008	NICB	Vehicle manufactured and shipped to original dealer
06/19/2008	Lustine Toyota Dodge Chrysler Jeep Woodbridge, VA 703-643-1440 lustine.com  4.3 / 5.0 266 Verified Reviews   7,035 Customer Favorites CARFAX Customer Favorites is the number of	Vehicle sold

		customers who identify this shop as their preferred service shop.	
06/19/2008	51	Virginia Motor Vehicle Dept.	Vehicle purchase reported Titled or registered as personal vehicle
07/02/2008		Virginia Motor Vehicle Dept. Fredericksburg, VA	Title or registration issued First owner reported
08/15/2008	5,163	Rosner Toyota Fredericksburg, VA 540-898-7900 rosnerauto.com ★ 4.8 / 5.0 ^{30 Verified} Reviews 	 Vehicle serviced Maintenance inspection completed Oil and filter changed Tires rotated
12/01/2008		Virginia Motor Vehicle Dept. Fredericksburg, VA	Registration issued or renewed Loan or lien reported
06/29/2009	22,697	Affordable Automotive Fredericksburg, VA 540-710-5400 ★ 4.8 / 5.0 ^{21 Verified} Reviews   18 Customer Favorites CARFAX Customer Favorites is the number of customers who identify this shop as their preferred service shop.	 Vehicle serviced Emissions or safety inspection performed
12/01/2009		Virginia Motor Vehicle Dept. Fredericksburg, VA	Registration issued or renewed Loan or lien reported
11/30/2010		Virginia Motor Vehicle Dept. Fredericksburg, VA	Registration issued or renewed Loan or lien reported
12/10/2011		Virginia Motor Vehicle Dept. Fredericksburg, VA	Registration issued or renewed Loan or lien reported
02/24/2012	76,221	Sears Auto Center Fredericksburg, VA 540-786-1655 searsauto.com ★ 4.6 / 5.0 ^{46 Verified} Reviews 	 Vehicle serviced Oil and filter changed
05/14/2012	81,585	Sears Auto Center Fredericksburg, VA	 Vehicle serviced Tires rotated

	540-786-1655 searsauto.com	Oil and filter changed
	★ 4.6 / 5.0 46 Verified Reviews 	
07/10/2012 86,912	Sears Auto Center Fredericksburg, VA 540-786-1655 searsauto.com	 Vehicle serviced Maintenance inspection completed Oil and filter changed
	★ 4.6 / 5.0 46 Verified Reviews 	
07/12/2012 86,997	Virginia Inspection Station	Passed safety inspection
09/18/2012 92,406	Sears Auto Center Fredericksburg, VA 540-786-1655 searsauto.com	 Vehicle serviced Maintenance inspection completed Oil and filter changed
	★ 4.6 / 5.0 46 Verified Reviews 	
10/19/2012	Virginia Motor Vehicle Dept.	Vehicle purchase reported
01/02/2013 93,790	Virginia Motor Vehicle Dept. Atlanta, GA	Title issued or updated Registration issued or renewed Vehicle repossessed
01/21/2013	Auto Auction	Vehicle sold
02/11/2013	New Jersey Motor Vehicle Dept. Lakewood, NJ Title #LK20130420285	Title issued or updated Dealer took title of this vehicle while it was in inventory Registration issued or renewed Vehicle color noted as Silver

Owner 2		Personal Vehicle
Purchased: 2013		11,641 mi/yr
Mileage	Source	Comments
03/05/2013	New Jersey Motor Vehicle Dept. Lakewood, NJ Title #LK20130640119	Title issued or updated Registration issued or renewed New owner reported Vehicle color noted as Silver
05/22/2014	Toyota Motor Sales, USA, Inc.	Manufacturer Safety recall issued NHTSA #14V273 Recall #E0S SAFETY RECALL E0S REMEDY PHASE 2 - 2004 THROUGH CERTAIN 2011 MY TOYOTA SIENNA (2WD) VEHICLES EXCESSIVE CORROSION OF THE SPARE TIRE CARRIER CARI F

STATUS: RECALL
Status: Remedy Available

Locate an authorized [Toyota dealer](#) near you to schedule an appointment

- [Learn more about this recall](#)

Description: Toyota has received reports indicating that some vehicles experienced symptoms of the recalled condition after being inspected or repaired. Due to the variation in the placement of the lightweight, foam water splash protector which is installed in front of the spare tire carrier or loss of the protector during normal usage, water splashed rearward with high concentrations of road salt can reach the spare tire carrier and corrode the spare tire carrier assembly cable.

In limited instances, the spare tire stowed under the floor may become separated from the spare tire carrier and become a road hazard that could cause a vehicle crash.

Remedy: Toyota dealers will be requested to inspect and, if necessary, replace the entire Spare Tire Carrier with an improved one. This replacement will be performed at NO CHARGE to the customer.

06/10/2014 105,095



Toyota World of Lakewood
Lakewood, NJ
732-364-9000
lakewoodtoyota.com



Vehicle serviced
Vehicle washed/detailed
Shift interlock solenoid replaced

★ 4.6 / 5.0 [72 Verified Reviews](#)



231
Customer Favorites
CARFAX Customer Favorites is the number of customers who identify this shop as their preferred service shop.

07/01/2014 105,675



DCH Freehold Toyota
Freehold, NJ
732-431-1300
dchfreeholdtoyota.com



Vehicle serviced
Vehicle washed/detailed

★ 4.4 / 5.0 [147 Verified Reviews](#)



324
Customer Favorites
CARFAX Customer Favorites is the number of customers who identify this shop as their preferred service shop.

07/23/2014 106,188



DCH Freehold Toyota
Freehold, NJ
732-431-1300
dchfreeholdtoyota.com





Vehicle serviced

★ 4.4 / 5.0 [147 Verified Reviews](#)



324

Customer Favorites
CARFAX Customer Favorites is the number of customers who identify this shop as their preferred service shop.

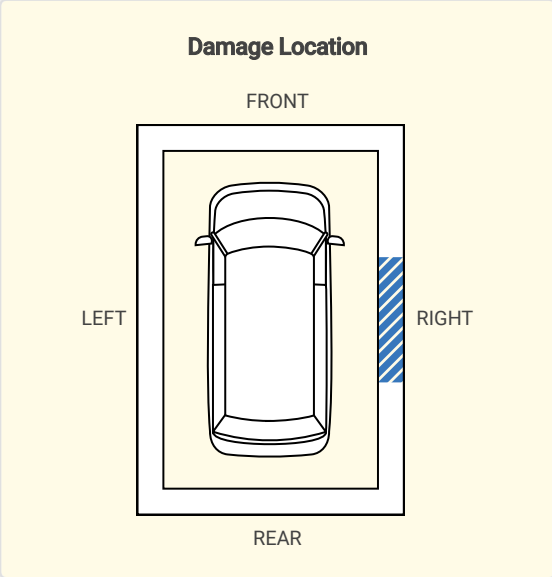
04/30/2015	New Jersey Motor Vehicle Dept. Lakewood, NJ	Registration issued or renewed Vehicle color noted as Silver
05/31/2015	New Jersey Motor Vehicle Dept. Lakewood, NJ	Registration issued or renewed Registration updated when owner moved the vehicle to a new location Vehicle color noted as Silver
04/20/2016	New Jersey Motor Vehicle Dept. Lakewood, NJ	Registration issued or renewed Vehicle color noted as Silver
03/23/2017	New Jersey Motor Vehicle Dept. Lakewood, NJ	Registration issued or renewed Vehicle color noted as Silver
09/28/2017 142,519	New Jersey Inspection Station	Passed emissions inspection
01/19/2018	New Jersey Motor Vehicle Dept. Lakewood, NJ	Registration issued or renewed Vehicle color noted as Silver
08/27/2018 	New Jersey Damage Report	 Accident reported Involving right side impact with another motor vehicle Right side primarily damaged
		

10/29/2018

Damage Report



Damage reported
Damage to front
Damage to right front



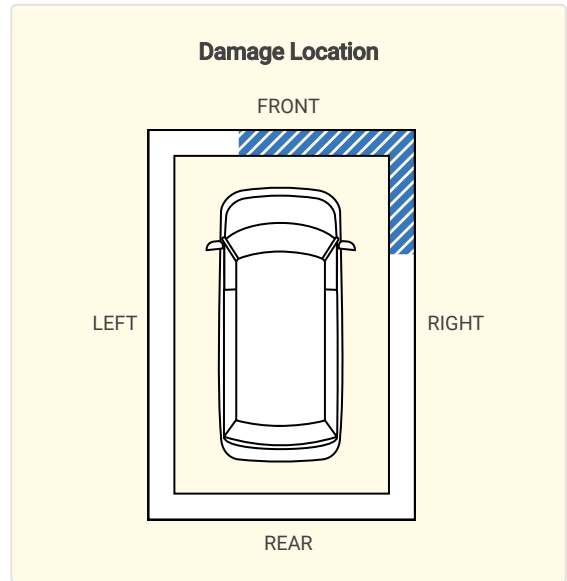

12/27/2018

Damage Report



TOTAL LOSS VEHICLE



There are many reasons an insurance company will declare a vehicle a total loss. Have this vehicle inspected by a qualified technician before you buy. [Learn more](#)

12/27/2018

New Jersey
Motor Vehicle Dept.

Title or registration issued to insurance company

12/27/2018 158,074

New Jersey
Motor Vehicle Dept.
Conshohocken, PA
Title #HH20183610145



**SALVAGE TITLE/CERTIFICATE ISSUED
RECONSTRUCTED TITLE ISSUED**

Vehicle color noted as Silver



01/07/2019

New Jersey
Damage Report



Accident reported
Involving left front impact with another motor vehicle
Left front primarily damaged
Vehicle disabled
Vehicle towed



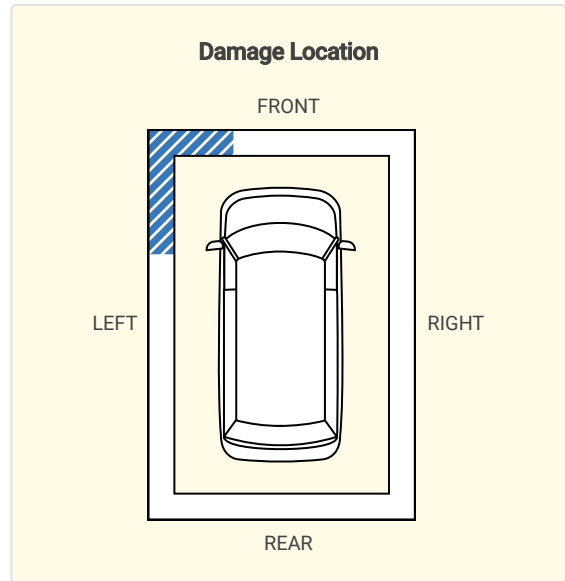

02/04/2019

Vehicle Exporter

Vehicle exported from Newark, NJ and imported to Nigeria



Glossary

Accident Indicator

CARFAX receives information about accidents in all 50 states, the District of Columbia and Canada.

Not every accident is reported to CARFAX. As details about the accident become available, those additional details are added to the CARFAX Vehicle History Report. CARFAX recommends that you have this vehicle inspected by a qualified mechanic.

- According to the National Safety Council, Injury Facts, 2015 edition, 8% of the 254 million registered vehicles in the U.S. were involved in an accident in 2013. Over 74% of these were considered minor or moderate.
- This CARFAX Vehicle History Report is based only on information supplied to CARFAX and available as of 7/29/20 at 10:34:30 AM (CDT). Other information about this vehicle, including problems, may not have been reported to CARFAX. Use this report as one important tool, along with a vehicle inspection and test drive, to make a better decision about your next used car.

Damage Indicator

Damage can be a result of many different types of events. Examples include contact with objects (other cars, trees, traffic signs, road debris, etc), vandalism, or weather-related events. Not every damage event is reported to CARFAX. As details about the damage event become available, those additional details are added to the CARFAX Vehicle History Report. CARFAX recommends that you have this vehicle inspected by a qualified mechanic.

- This CARFAX Vehicle History Report is based only on information supplied to CARFAX and available as of 7/29/20 at 10:34:30 AM (CDT). Other information about this vehicle, including problems, may not have been reported to CARFAX. Use this report as one important tool, along with a vehicle inspection and test drive, to make a better decision about your next used car.

First Owner

When the first owner(s) obtains a title from a Department of Motor Vehicles as proof of ownership.

Manufacturer Recall

Automobile manufacturers issue recall notices to inform owners of car defects that have come to the manufacturer's attention. Recalls also suggest improvements that can be made to improve the safety of a

particular vehicle. Most manufacturer recalls can be repaired at no cost to you.

New Owner Reported

When a vehicle is sold to a new owner, the Title must be transferred to the new owner(s) at a Department of Motor Vehicles.

Ownership History

CARFAX defines an owner as an individual or business that possesses and uses a vehicle. Not all title transactions represent changes in ownership. To provide estimated number of owners, CARFAX proprietary technology analyzes all the events in a vehicle history. Estimated ownership is available for vehicles manufactured after 1991 and titled solely in the US including Puerto Rico. Dealers sometimes opt to take ownership of a vehicle and are required to in the following states: Maine, Massachusetts, New Jersey, Ohio, Oklahoma, Pennsylvania and South Dakota. Please consider this as you review a vehicle's estimated ownership history.

Rebuilt/Reconstructed Title

A Rebuilt/Reconstructed vehicle is a salvage vehicle that has been repaired and restored to operation. These vehicles are often severely damaged before they are rebuilt and refurbished parts are typically used during reconstruction. In most states, an inspection of the vehicle is required before the vehicle is allowed to return to the road.

Repossession

When a repossession occurs a vehicle owner fails to make loan payments, and the financial institution holding the title takes possession of the vehicle.

Salvage Title

A Salvage Title is issued on a vehicle damaged to the extent that the cost of repairing the vehicle exceeds approximately 75% of its pre-damage value. This damage threshold may vary by state. Some states treat Junk titles the same as Salvage but the majority use this title to indicate that a vehicle is not road worthy and cannot be titled again in that state. The following eleven states also use Salvage titles to identify stolen vehicles - AZ, FL, GA, IL, MD, MN, NJ, NM, NY, OK and OR.

Title Issued

A state issues a title to provide a vehicle owner with proof of ownership. Each title has a unique number. Each title or registration record on a CARFAX report does not necessarily indicate a change in ownership. In Canada, a registration and bill of sale are used as proof of ownership.

Total Loss Vehicle

An insurance or fleet company declares a vehicle a total loss when a claim exceeds approximately 75% of its pre-damage value or if the vehicle is stolen and not recovered. This damage threshold varies by company. These companies typically take possession and obtain the title. Not all total loss vehicles result in a DMV-reported branded title. This may occur when an insurance company's definition of a total loss is different than the state DMV's definition for a branded title or when the owner of the vehicle is a self-insured company, like a fleet or rental company.

Toyota Recall / Service Campaign

Portions of this report have been included under license from Toyota Motor North America, Inc. ("TOYOTA"), License Agreement TMS1013 . This data applies only to vehicle marketed or originally sold in Mexico and the United States of America, including Guam, Saipan, American Samoa, Puerto Rico, the U.S. Virgin Islands and the other United States territories and protectorates with currently open safety or emissions recalls, or service campaigns. While TOYOTA provides data to Carfax Inc. on a regular basis, this report may not include very recent activity. For the manufacturer's most current information on recall/campaign activity for any Toyota, Lexus or Scion brand vehicle, you must go to <http://toyota.com/recall> or <http://lexus.com/recall>.

Follow Us:  facebook.com/CARFAX  [@CARFAXinc](https://twitter.com/CARFAXinc)  [About CARFAX](#)

CARFAX DEPENDS ON ITS SOURCES FOR THE ACCURACY AND RELIABILITY OF ITS INFORMATION. THEREFORE, NO RESPONSIBILITY IS ASSUMED BY CARFAX OR ITS AGENTS FOR ERRORS OR OMISSIONS IN THIS REPORT. CARFAX FURTHER EXPRESSLY DISCLAIMS ALL WARRANTIES, EXPRESS OR IMPLIED, INCLUDING ANY IMPLIED WARRANTIES OF MERCHANTABILITY OR FITNESS FOR A PARTICULAR PURPOSE. CARFAX®

© 2020 CARFAX, Inc., a unit of IHS Markit. All rights reserved.

Covered by United States Patent Nos. 7,112,852; 7,778,841; 7,506,512; 8,600,822; 8,505,070; 8,606,648; 7,505,828

I have reviewed and received a copy of the CARFAX Vehicle History Report for this 2008 TOYOTA SIENNA vehicle (VIN: 5TDZK23C78S210350), which is based on information supplied to CARFAX and available as of 7/29/20 at 11:34 AM (EDT).

Customer Signature

Date

Dealer Signature

Date